

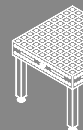

STOLOVI



NOGE STOLA



GRANIČNICI



KUTNICI



KLINOVI



STEGE & DODACI



PRIZME & NOSAČI



BRZOZATEZNE STEGE & ADAPTER



DODACI



SIEMUND WORKSTATION | SISTEM 28 + 22 + 16



Workstation

28
+
22
+
16



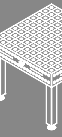

Stranica 412
Professional 750 plazma nitriran



Stranica 432
Stol za zavarivanje - po mjeri plazma nitriran



Stranica 434
Aluminijska ploča s rupama za stol



Stranica 436
Osmerokutni stol 150 plazma nitriran



Stranica 438
Osmerokutna ploča 18 plazma nitriran



Stranica 440
Podupiruća i stezna čahura

Professional 750



Professional 750

» **Tvrdoća površine do 750 Vickersa!**

Professional 750 stolovi za zavarivanje proizvedeni su od S355J2+N čelika te dodatno plazma nitrirani i premazani. Zbog povećane nosivosti stola za zavarivanje, osobito je pogodan za rad s teškim komponentama. Ako su stolovi opremljeni dijagonalnom mrežom, opcije stezanja gotovo da se udvostručuju.

NOGE STOLA

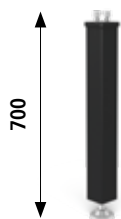

Stranica 446
Noga osnovna oprema

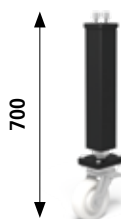

Stranica 448
Noga s kotačem i kočnicom



Stranica 447
Noga za stol podesiva po visini

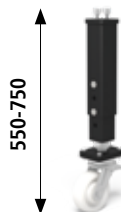

Stranica 449
Noga podesiva po visini sa kotačem i sa ručnom kočnicom

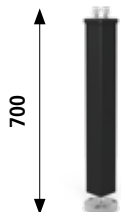

Stranica 450
Noga sa podnim učvršćenjem

Visina noge u mm.
Brojevi u crnom su standardne visine noge za gore prikazani stol. Sivi brojevi su, ovisno o tipu noge, bez dodatne naplate i moraju biti navedeni na narudžbi.

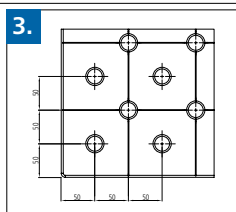
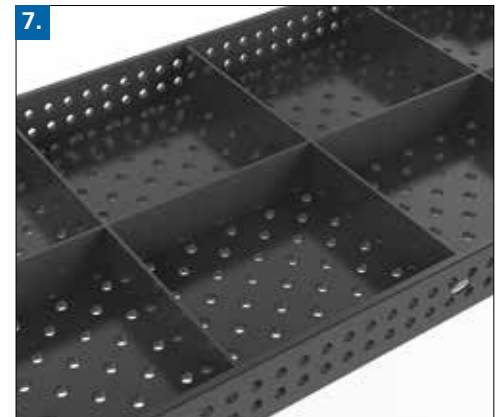
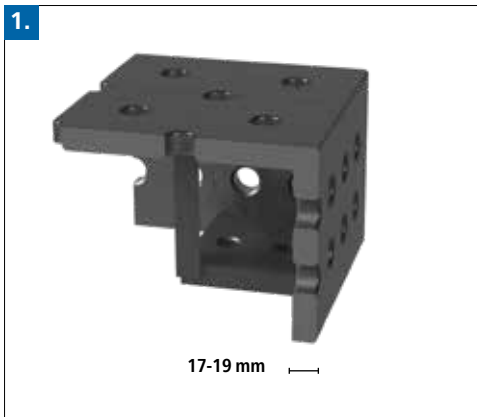
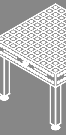

1. DEBLJINA MATERIJALA

- cca 17 – 19 mm

2. MATERIJAL

Kvalitet čelika S355J2+N,
plazmanitrirani s BAR premazom*

STUPANJ TVRDOĆE PREMA VICKERSU

Tvrdoća površine: cca 450 – 750
Tvrdoća baze: cca 165 – 220

* Zbog nedostatka tvrdoće materijala, stol Professional 750 brže se troši.

3. PODACI

- Dijagonalna rešetka
- Udaljenost rešetke 100 mm

4. STRANA STOLA

- visina 150 mm
- Rupe na bočnim stranama u rešetki 50 mm

5. RAZRAĐENI RADIJUSI

- radijus od 3 mm na gornjim, horizontalnim rubovima stola smanjuju oštećenja Siegmundove opreme i komponenti kupca
- radijus od 6 mm na vertikalnim, kutnim rubovima smanjuje rizik od ozljeda

6. SISTEM RUPA

- Ø 22 mm

Radijus R2,5 rupa na površini stola:

- smanjuju oštećenja na stolu, Siegmundovoj opremi i komponentama kupca
- za lakše umetanje vijaka i opreme
- manje oštećenja na rubovima rupa uzrokovanih pomicanjem teških komponenti
- veliki žlijeb na donjoj strani stola omogućava optimalnu snagu stiskanja vijaka (Vidi stranicu 476)

7. OJAČANJE

- s razmakom od 500 do 600 mm
- više ojačanja

8. NOGE STOLA

- oblikovana cijev 80x80 mm
- ploča noge Ø 90 mm
- 50 mm fino podesivo
(Podaci se odnose na model noge Basic)

9. KAPACITET

Kapacitet po jednoj nozi 1.000 kg
Maksimalno preporučeno opterećenje:
sa 4 noge = 2.000 kg
sa 6 nogu = 3.000 kg
sa 8 nogu = 4.000 kg
pri ravnomjernoj raspodjeli tereta.
(Podaci se odnose na model noge Basic)

Matematički gledano ukupno moguće opterećenje (kapacitet) je puno veće. No, navedeno moguće opterećenje je manje zbog sigurnosnih razloga.

Ukoliko vam je potrebno veće opterećenje, molimo da konzultirate proizvođača.

Professional 750 1200x800x150 mm

Opis:

Stol Professional 750 1200x800x150 mm s dijagonalnim položajem rupa na ploči stola te paralelnim položajem rupa na bočnim stranama u razmaku od 50 mm. Promjer provrta je 22 mm, a debljina materijala 17-19 mm. Stol je proizveden od visokokvalitetnog S355J2+N čelika. Razmak rupa od 100 mm pojednostavljuje postavljanje.



Težina: cca. 291 kg
Težina = Stol + Platform + Noga osnovna oprema

Slika pokazuje stol sa diagonalnom rešetkom.

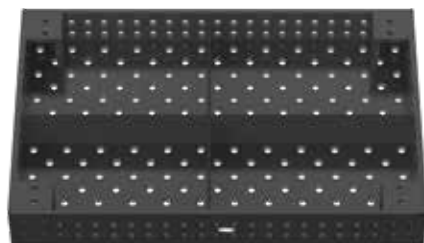

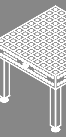

Professional 750
1200x800x150 mm

Professional 750 1200x800x150 - plazma nitriran	Professional 750 100 mm rešetke	Professional 750 Dijagonalna rešetka	Smanjena cijena bez plamanitracije
bez nogu	2-220025.P.T1 1.211,00 € ●	2-220025.PD.T1 1.366,00 € ●	2-225125 -233,00 € ○
sa Noga osnovna oprema Visina stola 850	2-220025.P 1.395,00 € ●	2-220025.PD 1.550,00 € ●	2-225125 -233,00 € ○

● = Proizvod je proizveden za skladište; ○ = Proizvod se proizvodi prema narudžbi; Objašnjenja pogledajte na stranici 84

Varijante nogu za stol za zavarivanje Professional 750					
Nadoplate Noga osnovna oprema 800 (Vidi stranicu 446) Promjena bez nadoplate 	Nadoplate Noga sa podnim učvršćenjem 700 (Vidi stranicu 450) 	Nadoplate Noga s kotačem i kočnicom 700 (Vidi stranicu 448) 	Nadoplate Noga za stol podesiva po visini 550-900 (Vidi stranicu 447) 	Nadoplate Noga za stol podesiva po visini 500-800 (Vidi stranicu 447) 	Nadoplate Noga podesiva po visini sa kotačem i sa ručnom kočnicom 600-850 (Vidi stranicu 449) 
2-220857.XX ●	2-220874.XX 52,00 €	2-220866.XX 74,00 €	2-220877.XX 55,00 €	2-220878.XX 55,00 €	2-220879.XX 89,00 €

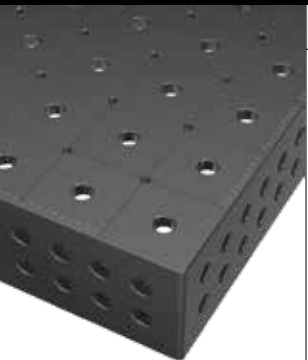
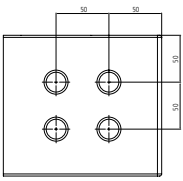
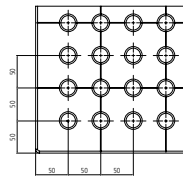
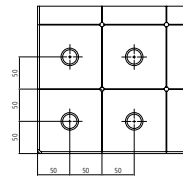
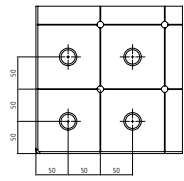
Posebna oprema za stolove Professional 750  Primjer za Dijagonalna rešetka M12	Strana stola		Površina		
	Naknada za duplo čvršće bočne stranice stola (Vidi stranicu 410) 		Rešetka 50 mm dodatno se naplaćuje (Vidi stranicu 82) 	Dodatna naplata dijagonalne rešetke Navoj M8 / M12 / M16 (Vidi stranicu 82) 	
Professional 750	2-226725 520,00 €	2-226525 454,00 €	M8 2-226125 479,00 €	M12 2-226225 479,00 €	M16 2-226325 479,00 €

Professional 750 1000x1000x150 mm

Opis:

Stol Professional 750 1000x1000x150 mm s dijagonalnim položajem rupa na ploči stola te paralelnim položajem rupa na bočnim stranama u razmaku od 50 mm. Promjer provrta je 22 mm, a debljina materijala 17-19 mm. Stol je proizveden od visokokvalitetnog S355J2+N čelika. Razmak rupa od 100 mm pojednostavljuje postavljanje.



Težina: cca. 296 kg
Težina = Stol + Platform + Noga osnovna oprema

Slika pokazuje stol sa diagonalnom rešetkom.

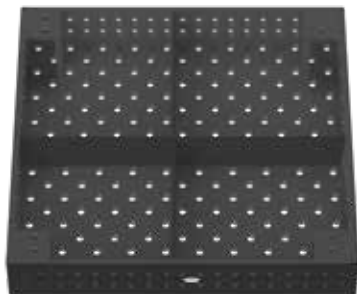

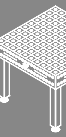

Professional 750
1000x1000x150 mm

Professional 750 1000x1000x150 - plazma nitriran	Professional 750 100 mm rešetke	Professional 750 Dijagonalna rešetka	Smanjena cijena bez plamanitracije
bez nogu	2-220010.P.T1 1.211,00 € ●	2-220010.PD.T1 1.366,00 € ●	2-225110 -233,00 € ○
sa Noga osnovna oprema Visina stola 850	2-220010.P 1.395,00 € ●	2-220010.PD 1.550,00 € ●	2-225110 -233,00 € ○

● = Proizvod je proizveden za skladište; ○ = Proizvod se proizvodi prema narudžbi; Objašnjenja pogledajte na stranici 84

Varijante nogu za stol za zavarivanje Professional 750					
Nadoplati Noga osnovna oprema 800 (Vidi stranicu 446) Promjena bez nadoplate 	Nadoplati Noga sa podnim učvršćenjem 700 (Vidi stranicu 450) 	Nadoplati Noga s kotačem i kočnicom 700 (Vidi stranicu 448) 	Nadoplati Noga za stol podesiva po visini 550-900 (Vidi stranicu 447) 	Nadoplati Noga za stol podesiva po visini 500-800 (Vidi stranicu 447) 	Nadoplati Noga podesiva po visini sa kotačem i sa ručnom kočnicom 600-850 (Vidi stranicu 449) 
2-220857.XX ●	2-220874.XX 52,00 €	2-220866.XX 74,00 €	2-220877.XX 55,00 €	2-220878.XX 55,00 €	2-220879.XX 89,00 €

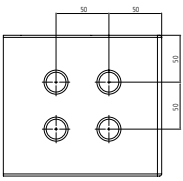
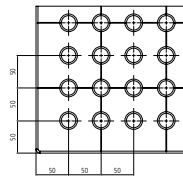
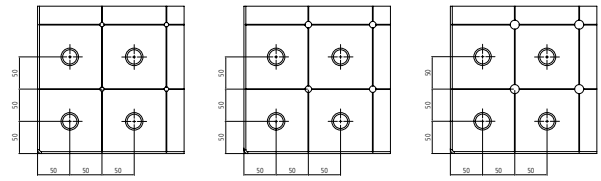
Posebna oprema za stolove Professional 750					
 Primjer za 50 mm rešetke	Strana stola		Površina		
	Naknada za duplo čvršće bočne stranice stola (Vidi stranicu 410) 			Rešetka 50 mm dodatno se naplaćuje (Vidi stranicu 82) 	Dodatna naplata dijagonalne rešetke Navoj M8 / M12 / M16 (Vidi stranicu 82) 
Professional 750	2-226710 520,00 €		2-226510 454,00 €	2-226110 479,00 €	2-226210 479,00 €
				2-226310 479,00 €	

Professional 750 1200x1200x150 mm

Opis:

Stol Professional 750 1200x1200x150 mm s dijagonalnim položajem rupa na ploči stola te paralelnim položajem rupa na bočnim stranama u razmaku od 50 mm. Promjer provrta je 22 mm, a debljina materijala 17-19 mm. Stol je proizveden od visokokvalitetnog S355J2+N čelika. Razmak rupa od 100 mm pojednostavljuje postavljanje.



Težina: cca. 387 kg
Težina = Stol + Platform + Noga osnovna oprema

Slika pokazuje stol sa diagonalnom rešetkom.

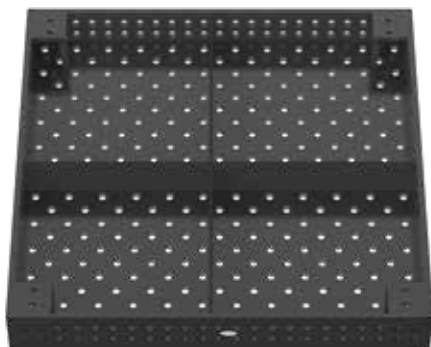

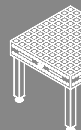

Professional 750
1200x1200x150 mm

Professional 750 1200x1200x150 - plazma nitriran	Professional 750 100 mm rešetke	Professional 750 Dijagonalna rešetka	Smanjena cijena bez plamanitracije
bez nogu	2-220015.P.T1 1.611,00 € ●	2-220015.PD.T1 1.810,00 € ●	2-225115 ○ -299,00 €
sa Noga osnovna oprema Visina stola 850	2-220015.P 1.795,00 € ●	2-220015.PD 1.994,00 € ●	2-225115 ○ -299,00 €

● = Proizvod je proizveden za skladište; ○ = Proizvod se proizvodi prema narudžbi; Objašnjenja pogledajte na stranici 84

Varijante nogu za stol za zavarivanje Professional 750					
Nadoplati Noga osnovna oprema 800 (Vidi stranicu 446) Promjena bez nadoplate 	Nadoplati Noga sa podnim učvršćenjem 700 (Vidi stranicu 450) 	Nadoplati Noga s kotačem i kočnicom 700 (Vidi stranicu 448) 	Nadoplati Noga za stol podesiva po visini 550-900 (Vidi stranicu 447) 	Nadoplati Noga za stol podesiva po visini 500-800 (Vidi stranicu 447) 	Nadoplati Noga podesiva po visini sa kotačem i sa ručnom kočnicom 600-850 (Vidi stranicu 449) 
2-220857.XX ●	2-220874.XX 52,00 €	2-220866.XX 74,00 €	2-220877.XX 55,00 €	2-220878.XX 55,00 €	2-220879.XX 89,00 €

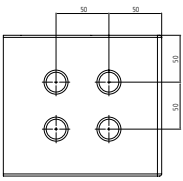
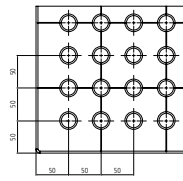
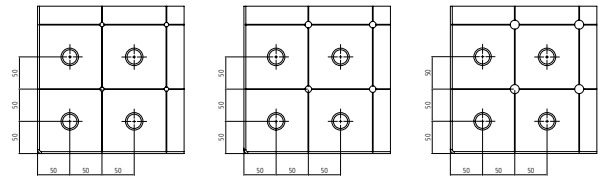
Posebna oprema za stolove Professional 750						
 Primjer za Dijagonalna rešetka M8	Strana stola		Površina			
	Naknada za duplo čvršće bočne stranice stola (Vidi stranicu 410) 		Rešetka 50 mm dodatno se naplaćuje (Vidi stranicu 82) 	Dodatna naplata dijagonalne rešetke Navoj M8 / M12 / M16 (Vidi stranicu 82) 	M8	M12
Professional 750	2-226715 629,00 €	2-226515 624,00 €	2-226115 479,00 €	2-226215 479,00 €	2-226315 479,00 €	

Professional 750 1500x1000x150 mm

Opis:

Stol Professional 750 1500x1000x150 mm s dijagonalnim položajem rupa na ploči stola te paralelnim položajem rupa na bočnim stranama u razmaku od 50 mm. Promjer provrta je 22 mm, a debljina materijala 17-19 mm. Stol je proizveden od visokokvalitetnog S355J2+N čelika. Razmak rupa od 100 mm pojednostavljuje postavljanje.



Težina: cca. 412 kg
Težina = Stol + Platform + Noga osnovna oprema

Slika pokazuje stol sa diagonalnom rešetkom.

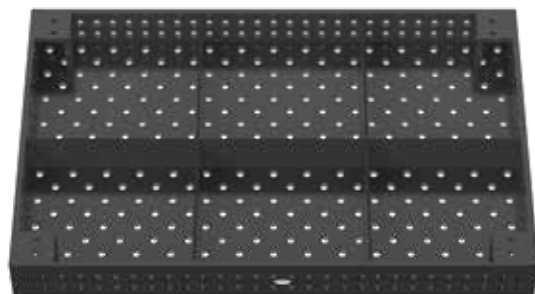

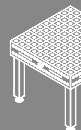

Professional 750 1500x1000x150 mm

Professional 750 1500x1000x150 - plazma nitriran	Professional 750 100 mm rešetke	Professional 750 Dijagonalna rešetka	Smanjena cijena bez plamanitracije
bez nogu	2-220035.P.T1 1.611,00 € ●	2-220035.PD.T1 1.810,00 € ●	2-225135 -299,00 € ○
sa Noga osnovna oprema Visina stola 850	2-220035.P 1.795,00 € ●	2-220035.PD 1.994,00 € ●	2-225135 -299,00 € ○

● = Proizvod je proizveden za skladište; ○ = Proizvod se proizvodi prema narudžbi; Objašnjenja pogledajte na stranici 84

Varijante nogu za stol za zavarivanje Professional 750					
Nadoplate Noga osnovna oprema 800 (Vidi stranicu 446) Promjena bez nadoplate 	Nadoplate Noga sa podnim učvršćenjem 700 (Vidi stranicu 450) 	Nadoplate Noga s kotačem i kočnicom 700 (Vidi stranicu 448) 	Nadoplate Noga za stol podesiva po visini 550-900 (Vidi stranicu 447) 	Nadoplate Noga za stol podesiva po visini 500-800 (Vidi stranicu 447) 	Nadoplate Noga podesiva po visini sa kotačem i sa ručnom kočnicom 600-850 (Vidi stranicu 449) 
2-220857.XX ●	2-220874.XX 52,00 €	2-220866.XX 74,00 €	2-220877.XX 55,00 €	2-220878.XX 55,00 €	2-220879.XX 89,00 €

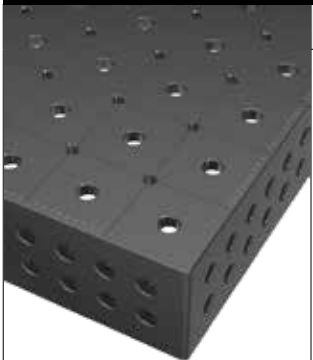
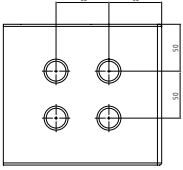
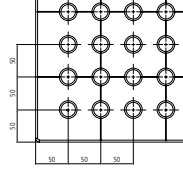
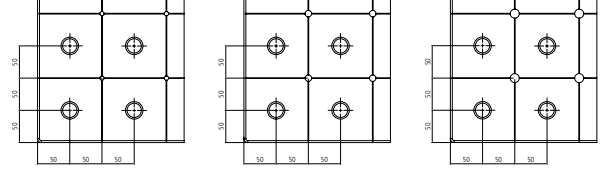
Posebna oprema za stolove Professional 750					
 Primjer za Dijagonalna rešetka M16	Strana stola		Površina		
	Naknada za duplo čvršće bočne stranice stola (Vidi stranicu 410) 			Rešetka 50 mm dodatno se naplaćuje (Vidi stranicu 82) 	Dodatna naplata dijagonalne rešetke Navoj M8 / M12 / M16 (Vidi stranicu 82) 
Professional 750	2-226735 657,00 €		2-226535 624,00 €	2-226135 479,00 €	2-226235 479,00 €
				M8 2-226335 479,00 €	M12 2-226335 479,00 €
					M16 2-226335 479,00 €

Professional 750 1500x1500x150 mm

Opis:

Stol Professional 750 1500x1500x150 mm s dijagonalnim položajem rupa na ploči stola te paralelnim položajem rupa na bočnim stranama u razmaku od 50 mm. Promjer provrta je 22 mm, a debljina materijala 17-19 mm. Stol je proizveden od visokokvalitetnog S355J2+N čelika. Razmak rupa od 100 mm pojednostavljuje postavljanje.



Težina: cca. 573 kg
Težina = Stol + Platform + Noga osnovna oprema

Slika pokazuje stol sa diagonalnom rešetkom.

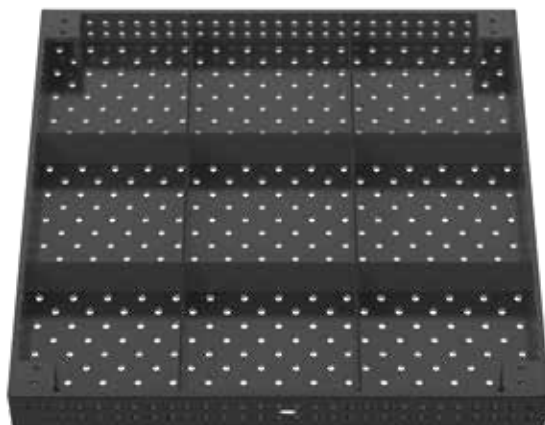

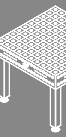

Professional 750 1500x1500x150 mm

Professional 750 1500x1500x150 - plazma nitriran	Professional 750 100 mm rešetke	Professional 750 Dijagonalna rešetka	Smanjena cijena bez plamanitracije
bez nogu	2-220050.P.T1 2.361,00 € ●	2-220050.PD.T1 2.699,00 € ●	2-225150 -432,00 € ○
sa Noga osnovna oprema Visina stola 850	2-220050.P 2.545,00 € ●	2-220050.PD 2.883,00 € ●	2-225150 -432,00 € ○

● = Proizvod je proizveden za skladište; ○ = Proizvod se proizvodi prema narudžbi; Objašnjenja pogledajte na stranici 84

Varijante nogu za stol za zavarivanje Professional 750					
Nadoplate Noga osnovna oprema 800 (Vidi stranicu 446) Promjena bez nadoplate 	Nadoplate Noga sa podnim učvršćenjem 700 (Vidi stranicu 450) 	Nadoplate Noga s kotačem i kočnicom 700 (Vidi stranicu 448) 	Nadoplate Noga za stol podesiva po visini 550-900 (Vidi stranicu 447) 	Nadoplate Noga za stol podesiva po visini 500-800 (Vidi stranicu 447) 	Nadoplate Noga podesiva po visini sa kotačem i sa ručnom kočnicom 600-850 (Vidi stranicu 449) 
2-220857.XX ●	2-220874.XX 52,00 €	2-220866.XX 74,00 €	2-220877.XX 55,00 €	2-220878.XX 55,00 €	2-220879.XX 89,00 €

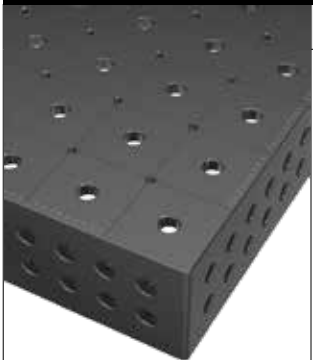
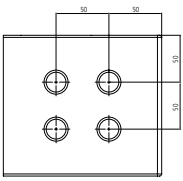
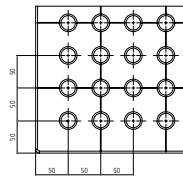
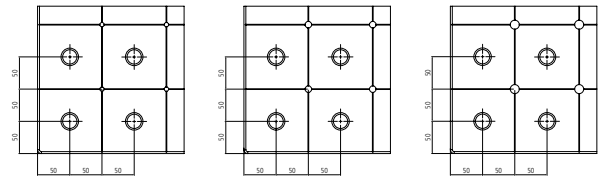
Posebna oprema za stolove Professional 750						
 Primjer za Dijagonalna rešetka M12	Strana stola		Površina			
	Naknada za duplo čvršće bočne stranice stola (Vidi stranicu 410) 			Rešetka 50 mm dodatno se naplaćuje (Vidi stranicu 82) 	Dodatna naplata dijagonalne rešetke Navoj M8 / M12 / M16 (Vidi stranicu 82) 	
Professional 750	2-226750 850,00 €		2-226550 898,00 €	2-226150 630,00 €	2-226250 630,00 €	2-226350 630,00 €

Professional 750 2000x1000x150 mm

Opis:

Stol Professional 750 2000x1000x150 mm s dijagonalnim položajem rupa na ploči stola te paralelnim položajem rupa na bočnim stranama u razmaku od 50 mm. Promjer provrta je 22 mm, a debljina materijala 17-19 mm. Stol je proizveden od visokokvalitetnog S355J2+N čelika. Razmak rupa od 100 mm pojednostavljuje postavljanje.



Težina: cca. 519 kg
Težina = Stol + Platform + Noga osnovna oprema

Slika pokazuje stol sa diagonalnom rešetkom.

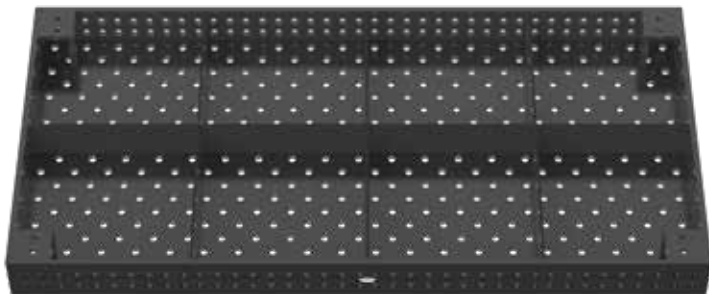

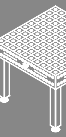

Professional 750 2000x1000x150 mm

Professional 750 2000x1000x150 - plazma nitriran	Professional 750 100 mm rešetke	Professional 750 Dijagonalna rešetka	Smanjena cijena bez plamanitracije
bez nogu	2-220020.P.T1 2.089,00 € ●	2-220020.PD.T1 ●	2-225120 ○ -379,00 €
sa Noga osnovna oprema Visina stola 850	2-220020.P ● 2.273,00 €	2-220020.PD ● 2.526,00 €	2-225120 ○ -379,00 €

● = Proizvod je proizveden za skladište; ○ = Proizvod se proizvodi prema narudžbi; Objašnjenja pogledajte na stranici 84

Varijante nogu za stol za zavarivanje Professional 750					
Nadoplate Noga osnovna oprema 800 (Vidi stranicu 446) Promjena bez nadoplate 	Nadoplate Noga sa podnim učvršćenjem 700 (Vidi stranicu 450) 	Nadoplate Noga s kotačem i kočnicom 700 (Vidi stranicu 448) 	Nadoplate Noga za stol podesiva po visini 550-900 (Vidi stranicu 447) 	Nadoplate Noga za stol podesiva po visini 500-800 (Vidi stranicu 447) 	Nadoplate Noga podesiva po visini sa kotačem i sa ručnom kočnicom 600-850 (Vidi stranicu 449) 
2-220857.XX ●	2-220874.XX 52,00 €	2-220866.XX 74,00 €	2-220877.XX 55,00 €	2-220878.XX 55,00 €	2-220879.XX 89,00 €

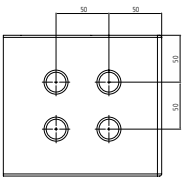
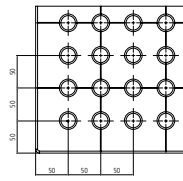
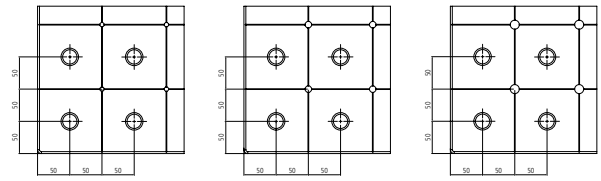
Posebna oprema za stolove Professional 750  Primjer za 50 mm rešetke	Strana stola		Površina			
	Naknada za duplo čvršće bočne stranice stola (Vidi stranicu 410) 		Rešetka 50 mm dodatno se naplaćuje (Vidi stranicu 82) 	Dodatna naplata dijagonalne rešetke Navoj M8 / M12 / M16 (Vidi stranicu 82) 	M8	M12
Professional 750	2-226720 817,00 €	2-226520 851,00 €	2-226120 630,00 €	2-226220 630,00 €	2-226320 630,00 €	

Professional 750 2000x2000x150 mm

Opis:

Stol Professional 750 2000x2000x150 mm s dijagonalnim položajem rupa na ploči stola te paralelnim položajem rupa na bočnim stranama u razmaku od 50 mm. Promjer provrta je 22 mm, a debljina materijala 17-19 mm. Stol je proizveden od visokokvalitetnog S355J2+N čelika. Razmak rupa od 100 mm pojednostavljuje postavljanje.



Težina: cca. 929 kg
Težina = Stol + Platform + Noga osnovna oprema

Slika pokazuje stol sa diagonalnom rešetkom.

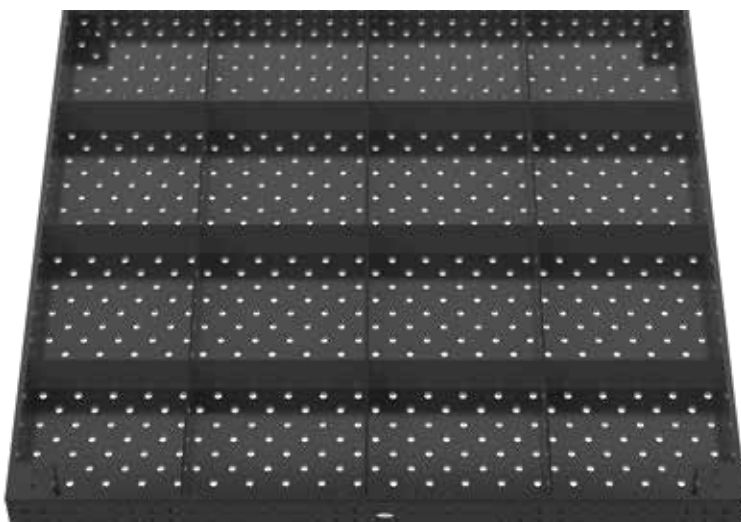

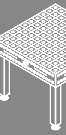

Professional 750
2000x2000x150 mm

Professional 750 2000x2000x150 - plazma nitriran	Professional 750 100 mm rešetke	Professional 750 Dijagonalna rešetka	Smanjena cijena bez plamanitracije
bez nogu	2-220045.P.T1 3.811,00 € ●	2-220045.PD.T1 4.254,00 € ●	2-225145 -666,00 € ○
sa Noga osnovna oprema Visina stola 850	2-220045.P 3.995,00 € ●	2-220045.PD 4.438,00 € ●	2-225145 -666,00 € ○

● = Proizvod je proizveden za skladište; ○ = Proizvod se proizvodi prema narudžbi; Objašnjenja pogledajte na stranici 84

Varijante nogu za stol za zavarivanje Professional 750					
Nadoplate Noga osnovna oprema 800 (Vidi stranicu 446) Promjena bez nadoplate 	Nadoplate Noga sa podnim učvršćenjem 700 (Vidi stranicu 450) 	Nadoplate Noga s kotačem i kočnicom 700 (Vidi stranicu 448) 	Nadoplate Noga za stol podesiva po visini 550-900 (Vidi stranicu 447) 	Nadoplate Noga za stol podesiva po visini 500-800 (Vidi stranicu 447) 	Nadoplate Noga podesiva po visini sa kotačem i sa ručnom kočnicom 600-850 (Vidi stranicu 449) 
2-220857.XX ●	2-220874.XX 52,00 €	2-220866.XX 74,00 €	2-220877.XX 55,00 €	2-220878.XX 55,00 €	2-220879.XX 89,00 €

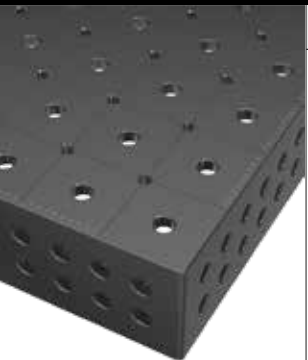
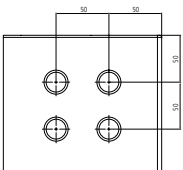
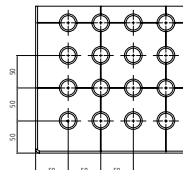
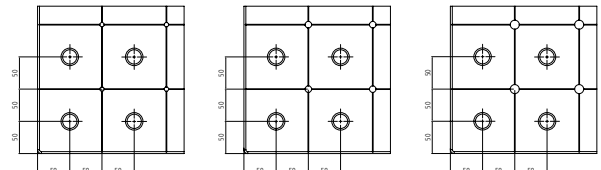
Posebna oprema za stolove Professional 750						
 Primjer za Dijagonalna rešetka M16	Strana stola		Površina			
	Naknada za duplo čvršće bočne stranice stola (Vidi stranicu 410) 			Rešetka 50 mm dodatno se naplaćuje (Vidi stranicu 82) 	Dodatna naplata dijagonalne rešetke Navoj M8 / M12 / M16 (Vidi stranicu 82) 	
Professional 750	2-226745 1.377,00 €		2-226545 1.635,00 €	2-226145 1.109,00 €	2-226245 1.109,00 €	
				M8	M12	M16
				2-226345 1.109,00 €		

Professional 750 2400x1200x150 mm

Opis:

Stol Professional 750 2400x1200x150 mm s dijagonalnim položajem rupa na ploči stola te paralelnim položajem rupa na bočnim stranama u razmaku od 50 mm. Promjer provrta je 22 mm, a debljina materijala 17-19 mm. Stol je proizveden od visokokvalitetnog S355J2+N čelika. Razmak rupa od 100 mm pojednostavljuje postavljanje.



Težina: cca. 724 kg
Težina = Stol + Platform + Noga osnovna oprema

Slika pokazuje stol sa diagonalnom rešetkom.

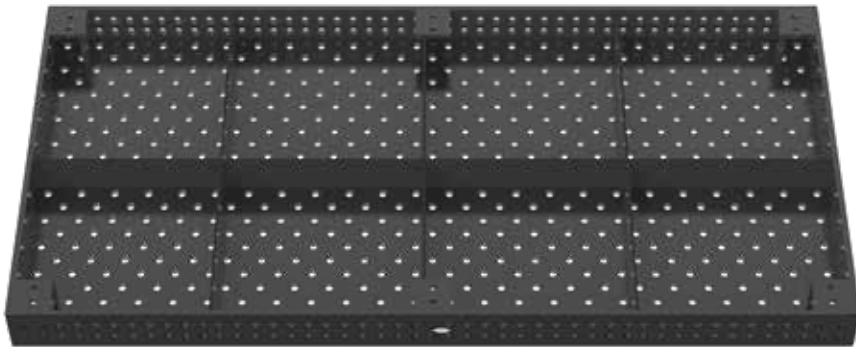

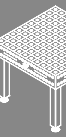

Professional 750
2400x1200x150 mm

Professional 750 2400x1200x150 - plazma nitriran	Professional 750 100 mm rešetke	Professional 750 Dijagonalna rešetka	Smanjena cijena bez plamanitracije
bez nogu	2-220030.P.T1 2.619,00 € ●	2-220030.PD.T1 2.941,00 € ●	2-225130 -483,00 € ○
sa Noga osnovna oprema Visina stola 850	2-220030.P 2.895,00 € ●	2-220030.PD 3.217,00 € ●	2-225130 -483,00 € ○

● = Proizvod je proizveden za skladište; ○ = Proizvod se proizvodi prema narudžbi; Objašnjenja pogledajte na stranici 84

Varijante nogu za stol za zavarivanje Professional 750				
Nadoplata Noga osnovna oprema 800 (Vidi stranicu 446) Promjena bez nadoplate 	Nadoplata Noga sa podnim učvršćenjem 700 (Vidi stranicu 450) 	Nadoplata Noga za stol podesiva po visini 550-900 (Vidi stranicu 447) 	Nadoplata Noga za stol podesiva po visini 500-800 (Vidi stranicu 447) 	
2-220857.XX ●	2-220874.XX 52,00 €	2-220877.XX 55,00 €	2-220878.XX 55,00 €	

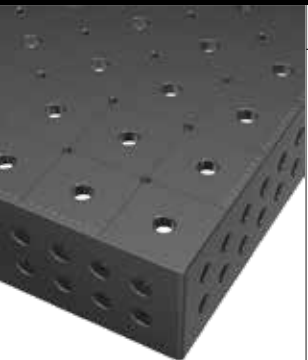
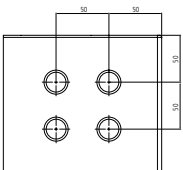
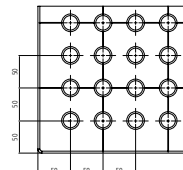
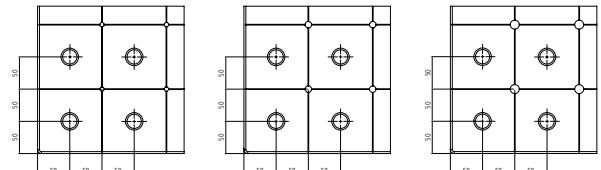
Posebna oprema za stolove Professional 750  Primjer za Dijagonalna rešetka M12	Strana stola		Površina			
	Naknada za duplo čvršće bočne stranice stola (Vidi stranicu 410) 		Rešetka 50 mm dodatno se naplaćuje (Vidi stranicu 82) 	Dodatna naplata dijagonalne rešetke Navoj M8 / M12 / M16 (Vidi stranicu 82) 		
Professional 750	2-226730 1.038,00 €		2-226530 1.130,00 €	2-226130 806,00 €	2-226230 806,00 €	2-226330 806,00 €

Professional 750 3000x1500x150 mm

Opis:

Stol Professional 750 3000x1500x150 mm s dijagonalnim položajem rupa na ploči stola te paralelnim položajem rupa na bočnim stranama u razmaku od 50 mm. Promjer provrta je 22 mm, a debljina materijala 17-19 mm. Stol je proizveden od visokokvalitetnog S355J2+N čelika. Razmak rupa od 100 mm pojednostavljuje postavljanje.



Težina: cca. 1.073 kg
Težina = Stol + Platform + Noga osnovna oprema

Slika pokazuje stol sa diagonalnom rešetkom.

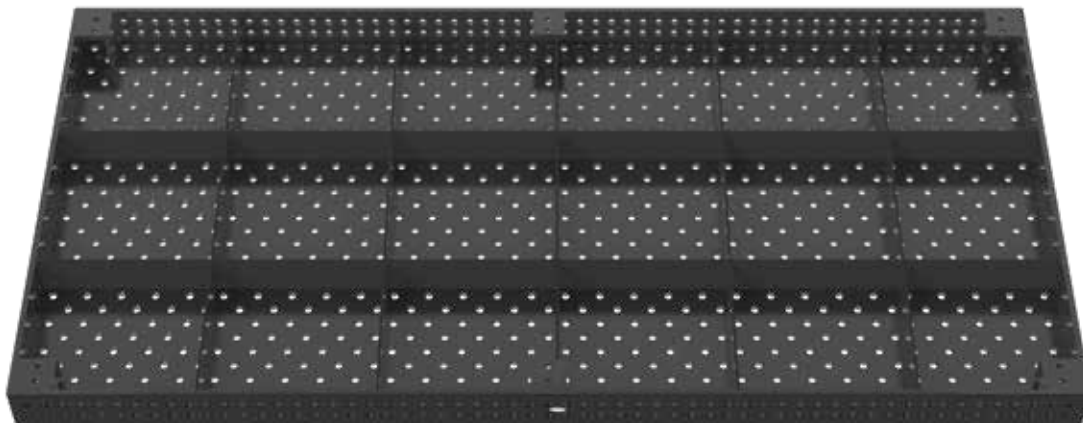

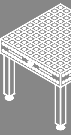

Professional 750
3000x1500x150 mm

Professional 750 3000x1500x150 - plazma nitriran	Professional 750 100 mm rešetke	Professional 750 Dijagonalna rešetka	Smanjena cijena bez plamanitracije
bez nogu	2-220040.P.T1 3.936,00 € ●	2-220040.PD.T1 4.404,00 € ●	2-225140 -702,00 € ○
sa Noga osnovna oprema Visina stola 850	2-220040.P 4.212,00 € ●	2-220040.PD 4.680,00 € ●	2-225140 -702,00 € ○

● = Proizvod je proizveden za skladište; ○ = Proizvod se proizvodi prema narudžbi; Objašnjenja pogledajte na stranici 84

Varijante nogu za stol za zavarivanje Professional 750				
Nadoplata Noga osnovna oprema 800 (Vidi stranicu 446) Promjena bez nadoplate 	Nadoplata Noga sa podnim učvršćenjem 700 (Vidi stranicu 450) 	Nadoplata Noga za stol podesiva po visini 550-900 (Vidi stranicu 447) 	Nadoplata Noga za stol podesiva po visini 500-800 (Vidi stranicu 447) 	
2-220857.XX ●	2-220874.XX 52,00 €	2-220877.XX 55,00 €	2-220878.XX 55,00 €	

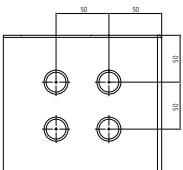
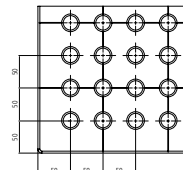
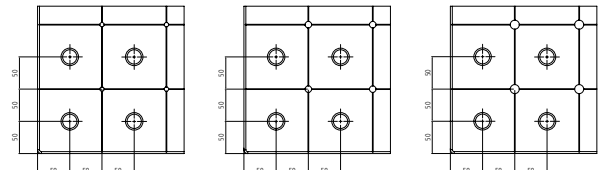
Posebna oprema za stolove Professional 750						
 Primjer za Dijagonalna rešetka M8	Strana stola		Površina			
	Naknada za duplo čvršće bočne stranice stola (Vidi stranicu 410) 		Rešetka 50 mm dodatno se naplaćuje (Vidi stranicu 82) 	Dodatna naplata dijagonalne rešetke Navoj M8 / M12 / M16 (Vidi stranicu 82) 		
Professional 750	2-226740 1.420,00 €		2-226540 1.805,00 €	2-226140 945,00 €	2-226240 945,00 €	2-226340 945,00 €

Professional 750 4000x2000x150 mm

Opis:

Stol Professional 750 4000x2000x150 mm s dijagonalnim položajem rupa na ploči stola te paralelnim položajem rupa na bočnim stranama u razmaku od 50 mm. Promjer provrta je 22 mm, a debljina materijala 17-19 mm. Stol je proizveden od visokokvalitetnog S355J2+N čelika. Razmak rupa od 100 mm pojednostavljuje postavljanje.



Težina: cca. 1.806 kg
Težina = Stol + Platform + Noga osnovna oprema

Slika pokazuje stol sa diagonalnom rešetkom.

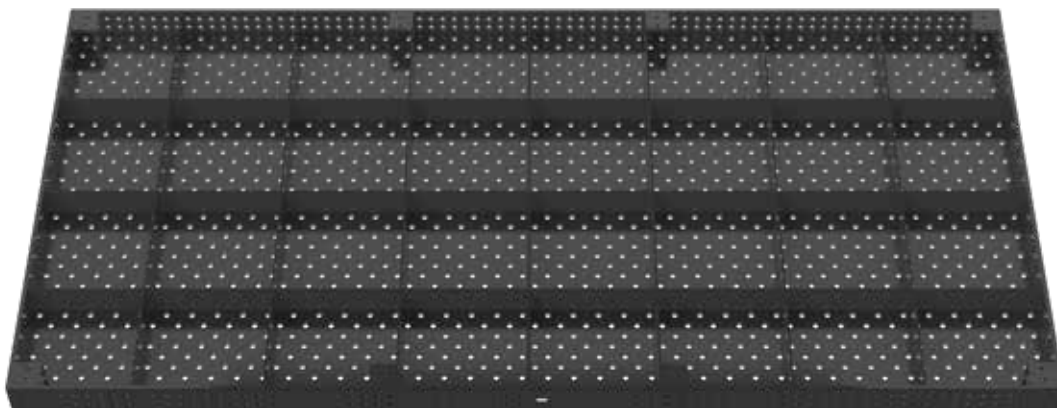

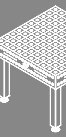

Professional 750
4000x2000x150 mm

Professional 750 4000x2000x150 - plazma nitriran	Professional 750 100 mm rešetke	Professional 750 Dijagonalna rešetka	Smanjena cijena bez plamanitracije
bez nogu	2-220055.P.T1 6.627,00 € ●	2-220055.PD.T1 7.404,00 € ●	2-225155 -1.166,00 € ○
sa Noga osnovna oprema Visina stola 850	2-220055.P 6.995,00 € ●	2-220055.PD 7.772,00 € ●	2-225155 -1.166,00 € ○

● = Proizvod je proizveden za skladište; ○ = Proizvod se proizvodi prema narudžbi; Objašnjenja pogledajte na stranici 84

Varijante nogu za stol za zavarivanje Professional 750				
Nadoplata Noga osnovna oprema 800 (Vidi stranicu 446) Promjena bez nadoplate 	Nadoplata Noga sa podnim učvršćenjem 700 (Vidi stranicu 450) 	Nadoplata Noga za stol podesiva po visini 550-900 (Vidi stranicu 447) 	Nadoplata Noga za stol podesiva po visini 500-800 (Vidi stranicu 447) 	
2-220857.XX ●	2-220874.XX 52,00 €	2-220877.XX 55,00 €	2-220878.XX 55,00 €	

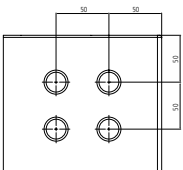
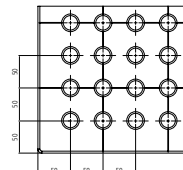
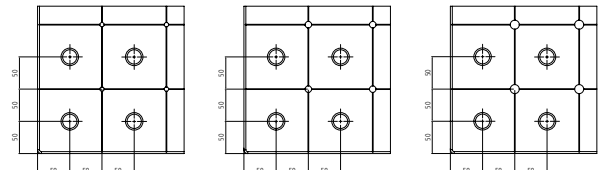
 Primjer za 50 mm rešetke	Strana stola		Površina			
	Naknada za duplo čvršće bočne stranice stola (Vidi stranicu 410) 		Rešetka 50 mm dodatno se naplaćuje (Vidi stranicu 82) 	Dodatna naplata dijagonalne rešetke Navoj M8 / M12 / M16 (Vidi stranicu 82) 	M8	M12
Professional 750	2-226755 ●	2-226555 3.109,00 €	2-226155 1.890,00 €	2-226255 1.890,00 €	2-226355 1.890,00 €	

Professional 750 - Specijalne veličine

Opis:

Za odabir dostupnih veličina (do maksimalnih 1400x3800 mm) pogledajte tablicu.

Više veličina dostupno je na upit.
Cijena ovisi o količini stolova.

Popust:

počevši od 2 komada: 5%
počevši od 5 komada: 10%
počevši od 10 komada: 15%

Pregled svih informacija vezane uz noge stola možete pronaći na stranici 444.

Specijalna oprema za stolove za zavarivanje dostupno je na zahtjev.

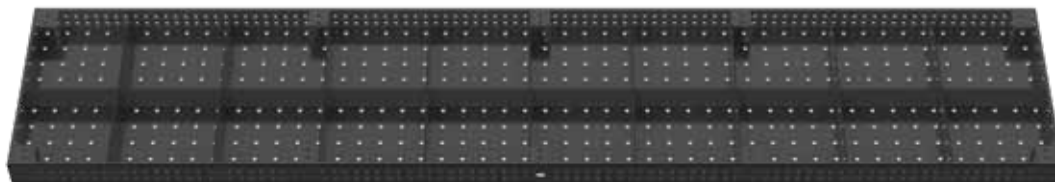

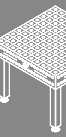

Professional 750 - Specijalne veličine

Dimenzije	Professional 750	Dimenzije	Professional 750	Dimenzije	Professional 750	Dimenzije	Professional 750
600 x 600	3.134,00 € 2-970606.P	800 x 3000	6.220,00 € 2-970830.P	1200 x 3400	8.180,00 € 2-971234.P	1600 x 3600	10.052,00 € 2-971636.P
600 x 800	3.337,00 € 2-970608.P	800 x 3200	6.460,00 € 2-970832.P	1200 x 3600	8.496,00 € 2-971236.P	1600 x 3800	10.447,00 € 2-971638.P
600 x 1000	3.539,00 € 2-970610.P	800 x 3400	6.700,00 € 2-970834.P	1200 x 3800	8.814,00 € 2-971238.P	1600 x 4000	10.841,00 € 2-971640.P
600 x 1200	3.740,00 € 2-970612.P	800 x 3600	6.941,00 € 2-970836.P	1200 x 4000	9.131,00 € 2-971240.P	1800 x 1800	6.940,00 € 2-971818.P
600 x 1400	3.942,00 € 2-970614.P	800 x 3800	7.181,00 € 2-970838.P	1400 x 1400	5.364,00 € 2-971414.P	1800 x 2000	7.372,00 € 2-971820.P
600 x 1600	4.144,00 € 2-970616.P	800 x 4000	7.421,00 € 2-970840.P	1400 x 1600	5.720,00 € 2-971416.P	1800 x 2200	7.804,00 € 2-971822.P
600 x 1800	4.346,00 € 2-970618.P	1000 x 1200	4.374,00 € 2-971012.P	1400 x 1800	6.075,00 € 2-971418.P	1800 x 2400	8.237,00 € 2-971824.P
600 x 2000	4.548,00 € 2-970620.P	1000 x 1400	4.654,00 € 2-971014.P	1400 x 2000	6.431,00 € 2-971420.P	1800 x 2600	8.669,00 € 2-971826.P
600 x 2200	4.750,00 € 2-970622.P	1000 x 1600	4.932,00 € 2-971016.P	1400 x 2200	6.786,00 € 2-971422.P	1800 x 2800	9.101,00 € 2-971828.P
600 x 2400	4.952,00 € 2-970624.P	1000 x 1800	5.211,00 € 2-971018.P	1400 x 2400	7.142,00 € 2-971424.P	1800 x 3000	9.533,00 € 2-971830.P
600 x 2600	5.153,00 € 2-970626.P	1000 x 2200	5.768,00 € 2-971022.P	1400 x 2600	7.497,00 € 2-971426.P	1800 x 3200	9.965,00 € 2-971832.P
600 x 2800	5.355,00 € 2-970628.P	1000 x 2400	6.046,00 € 2-971024.P	1400 x 2800	7.852,00 € 2-971428.P	1800 x 3400	10.399,00 € 2-971834.P
600 x 3000	5.557,00 € 2-970630.P	1000 x 2600	6.326,00 € 2-971026.P	1400 x 3000	8.209,00 € 2-971430.P	1800 x 3600	10.831,00 € 2-971836.P
600 x 3200	5.760,00 € 2-970632.P	1000 x 2800	6.604,00 € 2-971028.P	1400 x 3200	8.564,00 € 2-971432.P	1800 x 3800	11.263,00 € 2-971838.P
600 x 3400	5.961,00 € 2-970634.P	1000 x 3000	6.883,00 € 2-971030.P	1400 x 3400	8.919,00 € 2-971434.P	1800 x 4000	11.695,00 € 2-971840.P
600 x 3600	6.163,00 € 2-970636.P	1000 x 3200	7.161,00 € 2-971032.P	1400 x 3600	9.274,00 € 2-971436.P	2000 x 2000	7.843,00 € 2-972020.P
600 x 3800	6.365,00 € 2-970638.P	1000 x 3400	7.440,00 € 2-971034.P	1400 x 3800	9.630,00 € 2-971438.P	2000 x 2200	8.314,00 € 2-972022.P
600 x 4000	6.566,00 € 2-970640.P	1000 x 3600	7.719,00 € 2-971036.P	1400 x 4000	9.986,00 € 2-971440.P	2000 x 2400	8.784,00 € 2-972024.P
800 x 800	3.577,00 € 2-970808.P	1000 x 3800	7.998,00 € 2-971038.P	1600 x 1600	6.114,00 € 2-971616.P	2000 x 2600	9.255,00 € 2-972026.P
800 x 1000	3.817,00 € 2-970810.P	1000 x 4000	8.276,00 € 2-971040.P	1600 x 1800	6.508,00 € 2-971618.P	2000 x 2800	9.726,00 € 2-972028.P
800 x 1400	4.297,00 € 2-970814.P	1200 x 1400	5.009,00 € 2-971214.P	1600 x 2000	6.901,00 € 2-971620.P	2000 x 3000	10.197,00 € 2-972030.P
800 x 1600	4.538,00 € 2-970816.P	1200 x 1600	5.325,00 € 2-971216.P	1600 x 2200	7.295,00 € 2-971622.P	2000 x 3200	10.667,00 € 2-972032.P
800 x 1800	4.779,00 € 2-970818.P	1200 x 1800	5.643,00 € 2-971218.P	1600 x 2400	7.689,00 € 2-971624.P	2000 x 3400	11.138,00 € 2-972034.P
800 x 2000	5.018,00 € 2-970820.P	1200 x 2200	6.278,00 € 2-971222.P	1600 x 2600	8.083,00 € 2-971626.P	2000 x 3600	11.609,00 € 2-972036.P
800 x 2200	5.259,00 € 2-970822.P	1200 x 2600	6.911,00 € 2-971226.P	1600 x 2800	8.477,00 € 2-971628.P	2000 x 3800	12.079,00 € 2-972038.P
800 x 2400	5.500,00 € 2-970824.P	1200 x 2800	7.229,00 € 2-971228.P	1600 x 3000	8.871,00 € 2-971630.P		
800 x 2600	5.739,00 € 2-970826.P	1200 x 3000	7.545,00 € 2-971230.P	1600 x 3200	9.265,00 € 2-971632.P		
800 x 2800	5.980,00 € 2-970828.P	1200 x 3200	7.863,00 € 2-971232.P	1600 x 3400	9.658,00 € 2-971634.P		

Aluminijska ploča s rupama

Opis:

Aluminijska ploča s rupama posebno je razvijena za obradu nehrđajućeg čelika kako bi se odvojio čelik od nehrđajućeg čelika. Moguć je širok raspon primjene, jer se razmještaj rupa slaže s razmještajem rupa na stolu. Verzija ploče od nehrđajućeg čelika dostupna je na zahtjev.

Kako bi se izbjegli dodatni troškovi transporta, preporučamo dostavu ploče zajedno sa stolom.

Slike pojedinih veličina proizvoda možete pogledati na web-stranici www.siegmund.com.

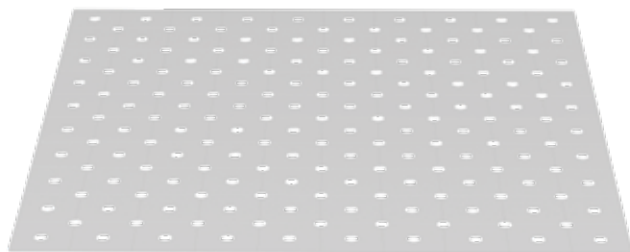
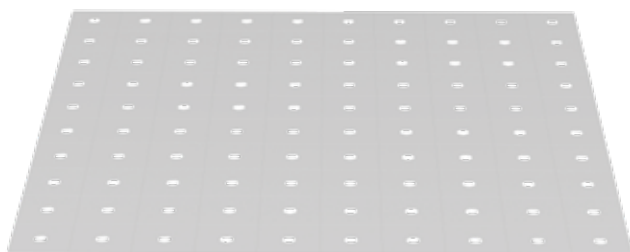

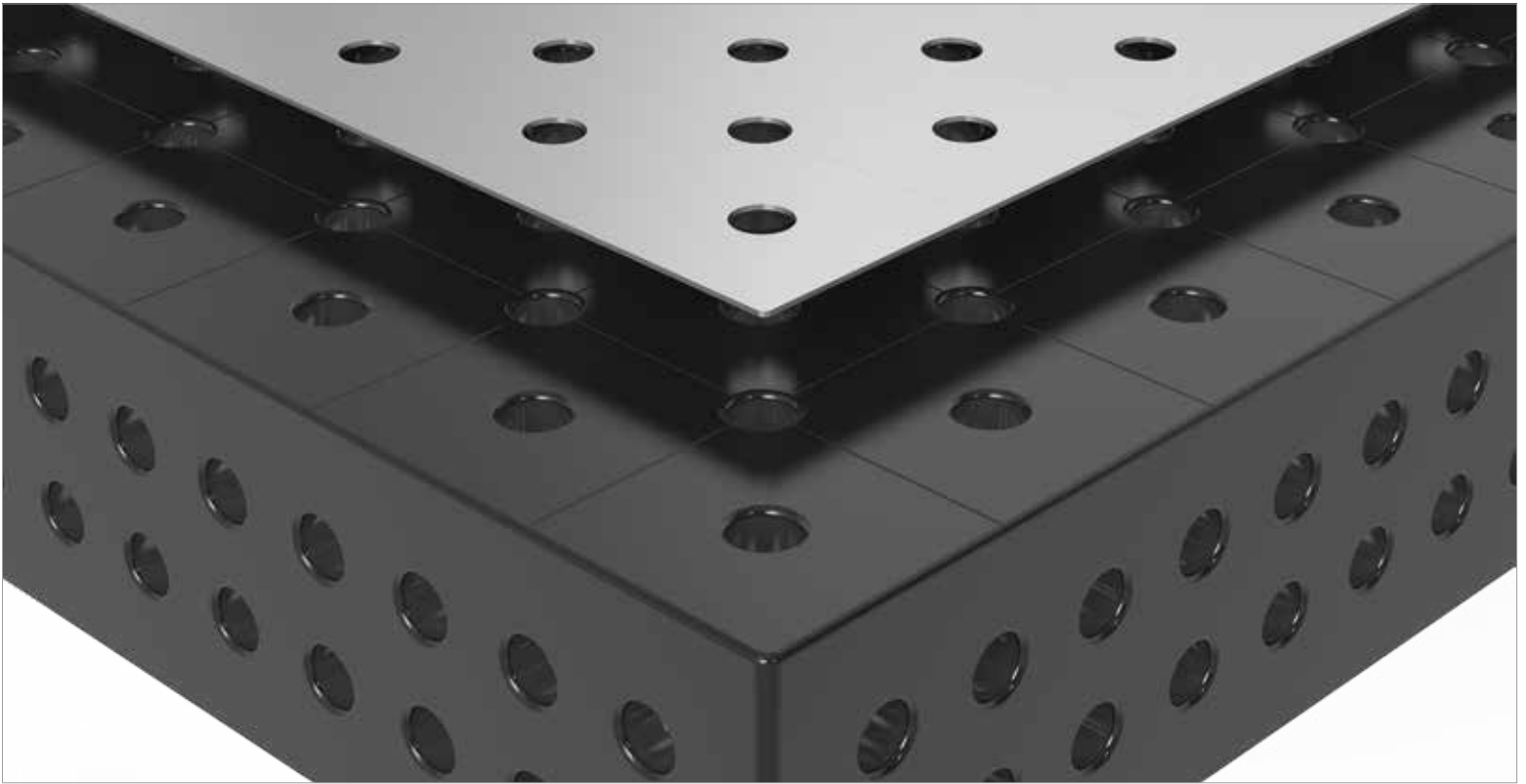
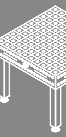

	Dužina: (a)	Širina: (b)	Visina: (c)	Težina:	Udaljenost rešetke 100 mm	Dijagonalna rešetka
Aluminijska ploča s rupama za stol 220010	994 mm	994 mm	2 mm	cca. 5,20 kg	2-220200 109,00 €	2-220200.D 139,00 €
Aluminijska ploča s rupama za stol 220025	1194 mm	1194 mm	2 mm	cca. 5,00 kg	2-220202 105,00 €	2-220202.D 134,00 €
Aluminijska ploča s rupama za stol 220015	1194 mm	994 mm	2 mm	cca. 7,50 kg	2-220204 157,00 €	2-220204.D 201,00 €
Aluminijska ploča s rupama za stol 220035	1494 mm	994 mm	2 mm	cca. 7,70 kg	2-220206 164,00 €	2-220206.D 208,00 €
Aluminijska ploča s rupama za stol 220050	1494 mm	1494 mm	2 mm	cca. 12 kg	2-220207 246,00 €	2-220207.D 313,00 €
Aluminijska ploča s rupama za stol 220020	1994 mm	994 mm	2 mm	cca. 10 kg	2-220201 219,00 €	2-220201.D 279,00 €
Aluminijska ploča s rupama za stol 220060	1194 mm	994 mm	2 mm	cca. 6,20 kg	2-220208 132,00 €	2-220208.D 167,00 €
Aluminijska ploča s rupama za stol 220060 (2x 220208 / 220208.D)				cca. 12 kg	2-220208.2 262,00 €	2-220208.D.2 334,00 €
Aluminijska ploča s rupama za stol 220045 (2x 220201 / 220201.D)				cca. 21 kg	2-220201.2 438,00 €	2-220201.D.2 557,00 €
Aluminijska ploča s rupama za stol 220030 (2x 220204 / 220204.D)				cca. 15 kg	2-220204.2 315,00 €	2-220204.D.2 401,00 €
Aluminijska ploča s rupama za stol 220040 (2x 220207 / 220207.D)				cca. 23 kg	2-220207.2 493,00 €	2-220207.D.2 624,00 €
Aluminijska ploča s rupama za stol 220055 (4x 220201 / 220201.D)				cca. 41 kg	2-220201.4 876,00 €	2-220201.D.4 1.115,00 €
Aluminijska ploča s rupama za stol 220040 (3x 220206 / 220206.D)				cca. 23 kg	2-220206.3 492,00 €	2-220206.D.3 624,00 €

● = Proizvod je proizveden za skladište; ○ = Proizvod se proizvodi prema narudžbi; Objašnjenja pogledajte na stranici 84

Osmerokutni stol sa bočnim stranama 150 mm

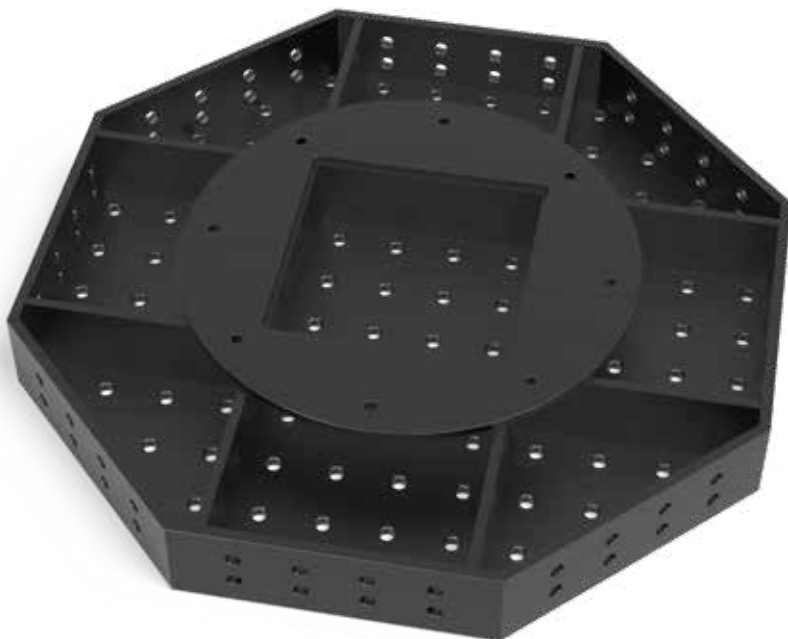
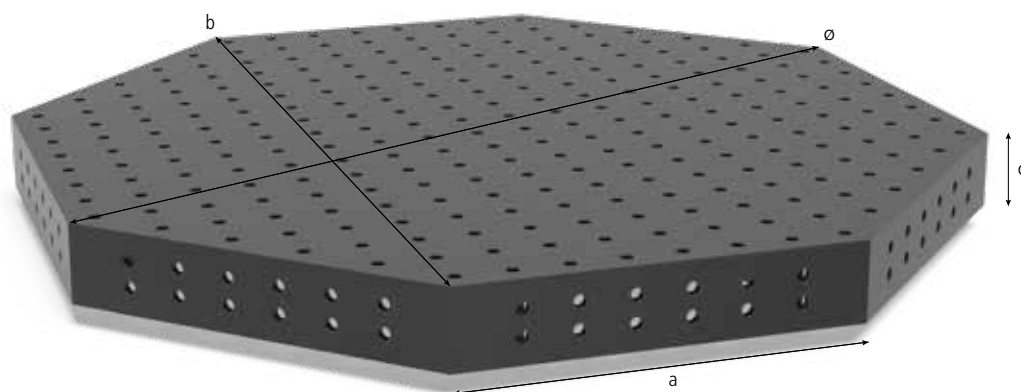

Opis:

Osmerokutni stol posebno je pogodan za upotrebu na manipulatorima robotskih stanica. Nudi slične mogućnosti stezanja kao Siegmundov stol za zavarivanje sistema 22 zbog paralelnog oblika otvora na vrhu. Kako bi zadovoljili vaše individualne zahtjeve, stol se može prilagoditi vašem proizvodnom okruženju na zahtjev.

Ploča je izrađena od materijala S355J2+N čelik.

Cijene ovise o količini.

Popust:

počevši od 2 komada: 5%
počevši od 5 komada: 10%
počevši od 10 komada: 15%

Kako bi povezali osmerokutnu ploču sa bočnim stranama sa adapterom potreban je priključak. Prema zahtjevu, za uobičajena napajanja proizvodimo adapter ploču sa specijalnim priključkom.

Zbog specifične prilagodbe kupcu težina može varirati.

Specijalna oprema za stolove za zavarivanje kao što je ljestvica, dijagonalna rešetka i ljestvica, kordinirana ljestvica, 50 mm rešetke ili dijagonalna rešetka sa navojima M8 / M12/ M16 dostupno je na zahtjev.

Slike pojedinih veličina proizvoda možete pogledati na web-stranici www.siegmund.com.

Podloške i adapteri nisu uključene u opremu osmerokutnog stola.

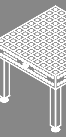

	Dužina: (a)	Širina: (b)	Visina: (c)	Ø: (o)	MS: (d)	Težina:	plazma nitiran
Osmerokutni stol SW 800x150 plazma nitiran bez nogu	331 mm	800 mm	150 mm	866 mm	18 mm	cca. 209 kg	2-920822.P 3.212,00 € ○
Osmerokutni stol SW 1000x150 plazma nitiran bez nogu	414 mm	1000 mm	150 mm	1082 mm	18 mm	cca. 276 kg	2-921022.P 3.685,00 € ○
Osmerokutni stol SW 1200x150 plazma nitiran bez nogu	497 mm	1200 mm	150 mm	1299 mm	18 mm	cca. 368 kg	2-921222.P 5.480,00 € ○
Osmerokutni stol SW 1400x150 plazma nitiran bez nogu	580 mm	1400 mm	150 mm	1515 mm	18 mm	cca. 477 kg	2-921422.P 5.953,00 € ○
Osmerokutni stol SW 1500x150 plazma nitiran bez nogu	621 mm	1500 mm	150 mm	1624 mm	18 mm	cca. 525 kg	2-921522.P 6.425,00 € ○
Osmerokutni stol SW 1600x150 plazma nitiran bez nogu	663 mm	1600 mm	150 mm	1732 mm	18 mm	cca. 604 kg	2-921622.P 6.898,00 € ○
Osmerokutni stol SW 1700x150 plazma nitiran bez nogu	704 mm	1700 mm	150 mm	1840 mm	18 mm	cca. 655 kg	2-921722.P 7.484,00 € ○
Osmerokutni stol SW 1800x150 plazma nitiran bez nogu	746 mm	1800 mm	150 mm	1948 mm	18 mm	cca. 710 kg	2-921822.P 7.370,00 € ○
Više veličina na upit							○
Naknada za prilagodbu adapter pločice							0-940000 532,00 € ○

MS=Debljina materijala; ● = Proizvod je proizveden za skladište; ○ = Proizvod se proizvodi prema narudžbi; Objašnjenja pogledajte na stranici 84

Osmerokutna ploča bez bočne površine

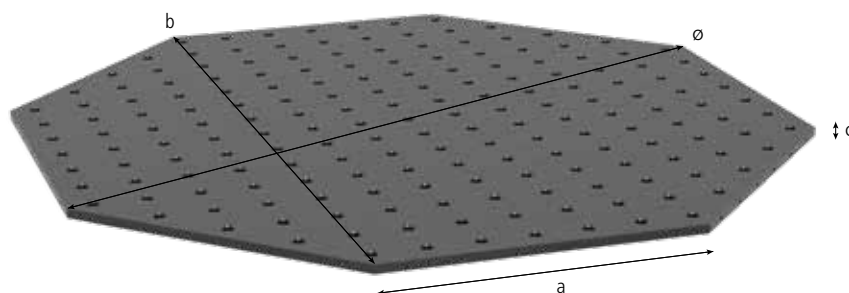

Opis:

Osmerokutni stol se najčešće koristi na manipulatorima u robotom-upravljanim ćelijama. Osmerokutni stol nudi jednake mogućnosti stezanja, kao i Siegmund-ov stol za zavarivanje Basic zbog svog paralelnog rasporeda rupa i rupa sa M8 navojem na stranama. Prema individualnim potrebama stol se može modificirati, na Vaš zahtjev.

Osmerokutna ploča bez bočnih površina može biti direktno fiksirana kroz provrte na manipulatoru uz upotrebu potpornih kućišta (artikl br. 220500) i klinova.

Ploča je izrađena od materijala S355J2+N čelik.

Cijene ovise o količini.

Popust:

počevši od 2 komada: 5%
počevši od 5 komada: 10%
počevši od 10 komada: 15%

Zbog specifične prilagodbe kupcu težina može varirati.

Specijalna oprema za stolove za zavarivanje kao što je ljestvica, dijagonalna rešetka i ljestvica, kordinirana ljestvica, 50 mm rešetke ili dijagonalna rešetka sa navojima M8 / M12 / M16 dostupno je na zahtjev.

Slike pojedinih veličina proizvoda možete pogledati na web-stranici www.siegmund.com.

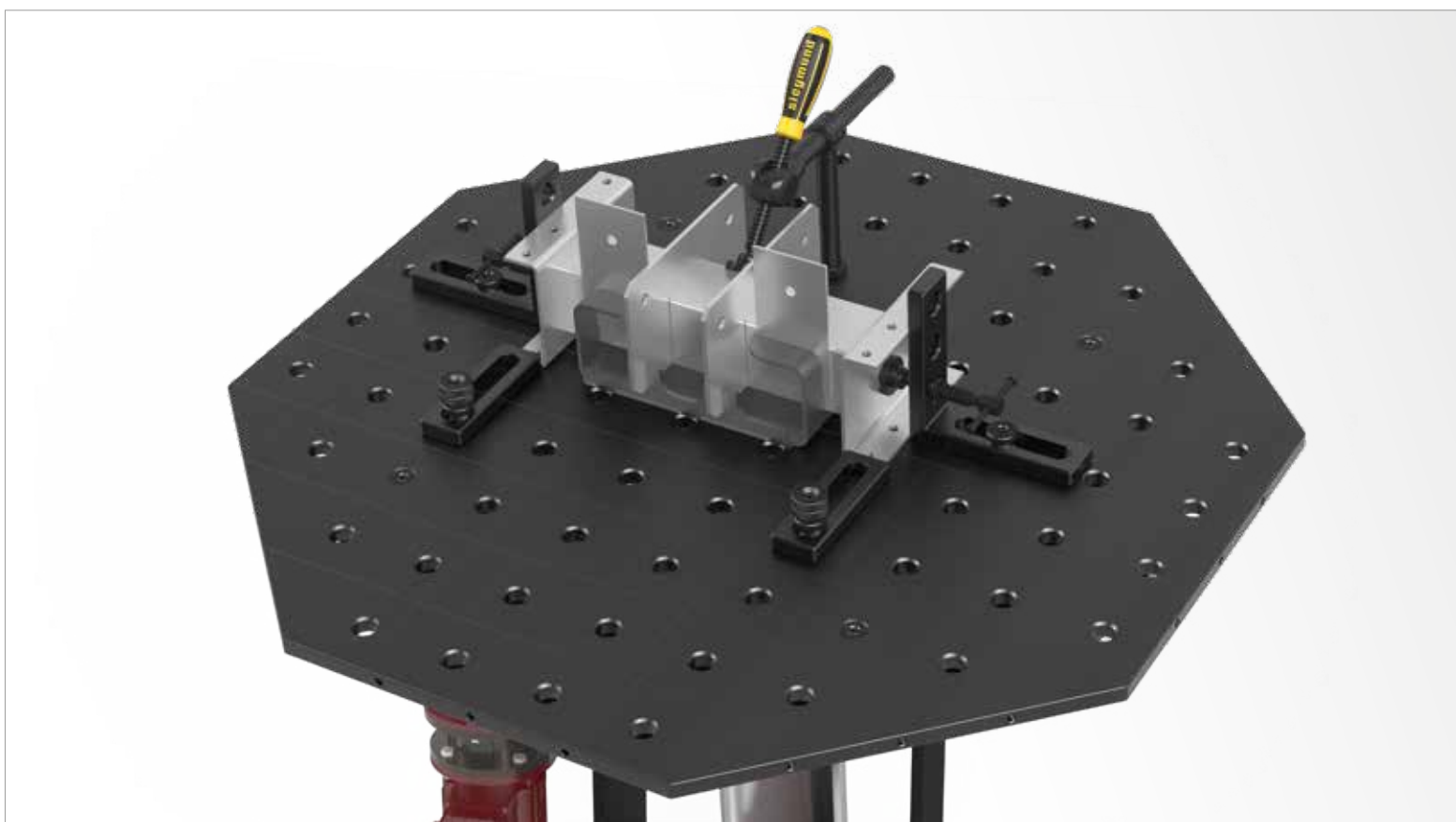
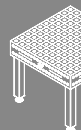

	Dužina: (a)	Širina: (b)	Visina: (c)	Ø: (o)	MS: (d)	Težina:	plazma nitriran
Osmerokutna ploča SW 600x18 plazma nitriran bez nogu	249 mm	600 mm	18 mm	649 mm	18 mm	cca. 79 kg	2-930600.P 1.511,00 € ○
Osmerokutna ploča SW 800x18 plazma nitriran bez nogu	331 mm	800 mm	18 mm	866 mm	18 mm	cca. 112 kg	2-930800.P 1.889,00 € ○
Osmerokutna ploča SW 1000x18 plazma nitriran bez nogu	414 mm	1000 mm	18 mm	1082 mm	18 mm	cca. 155 kg	2-931000.P 2.267,00 € ○
Osmerokutna ploča SW 1200x18 plazma nitriran bez nogu	497 mm	1200 mm	18 mm	1299 mm	18 mm	cca. 220 kg	2-931200.P 2.858,00 € ○
Osmerokutna ploča SW 1400x18 plazma nitriran bez nogu	580 mm	1400 mm	18 mm	1515 mm	18 mm	cca. 305 kg	2-931400.P 3.595,00 € ○
Osmerokutna ploča SW 1500x18 plazma nitriran bez nogu	621 mm	1500 mm	18 mm	1636 mm	18 mm	cca. 340 kg	2-931500.P 3.811,00 € ○
Više veličina na upit							. ○
Naknada za prilagođavanje veličina rupa po želji kupca.							0-940000.1 395,00 € ○

MS=Debljina materijala; ● = Proizvod je proizveden za skladište; ○ = Proizvod se proizvodi prema narudžbi; Objašnjenja pogledajte na stranici 84

Podupiruća i stezna čahura

Opis:

Brunirano podupiruća i stezna čahura je fleksibilan alat koji je potreban da se fiksiraju Siegmund-ove komponente s upuštenim klinom u bilo kojoj poziciji. Podupiruća i stezna čahura može biti zavarena ili pričvršćena na neku posebnu napravu i omogućiti brzo pričvršćivanje i zamjenu ploče sa upotrebom steznih klinova.

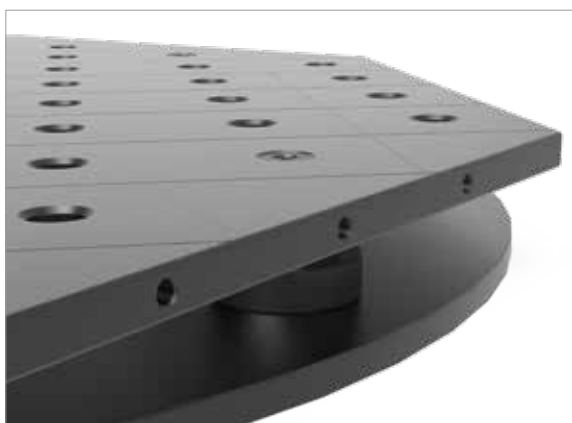

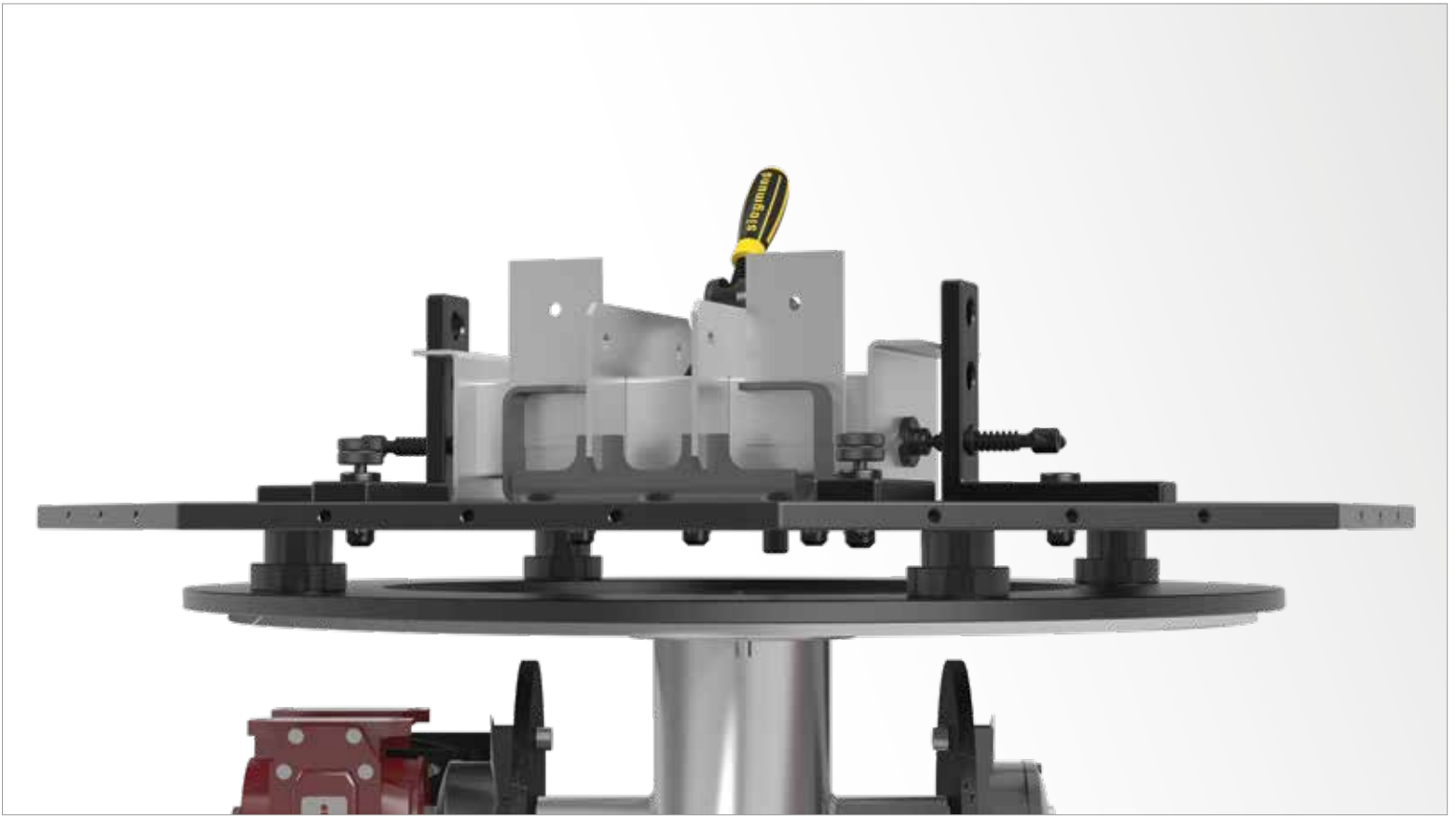
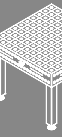

Visina: (c)

Ø: (o)

Težina:

Udaljenost rešetke
100 mm

Podupiruća i stezna čahura
- brunirano

45 mm

70 mm

cca. 0,70 kg

2-220500
21,00 € ○

● = Proizvod je proizveden za skladište; ○ = Proizvod se proizvodi prema narudžbi; Objašnjenja pogledajte na stranici 84